

A group of ants is shown building a small wooden structure made of sticks and twigs. The structure has a triangular roof and two vertical posts. The ants are positioned at various points on the structure, appearing to be working together. The background is a bright, sunny outdoor setting with green foliage and a clear blue sky. A ruler is visible on the left side of the structure, providing a sense of scale.

**bautech**®  
INDUSTRIAL DOORS

*“Together we are strong”*

[www.baufit.com](http://www.baufit.com)

## Bautech Automatic Door Systems,

Bautech founded in 1992 in the Netherlands and established manufacturing facility in Turkey in 2009. Since then we offer Innovative Design, Functionality, Quality and Durability with in house production of complete range of sectional door processes.

Bautech specializes in manufacturing full range of sectional Industrial door, commercial and residential sectional garage doors. Our sectional door systems are designed and engineered for complete satisfaction of professional dealers and installers.

We also have strategic alliances with top door automation manufacturers, allowing us to offer a complete range of industrial and garage door automation.

As a leader and well-known brand in local sectional door Market, Isodoor expands its sales network in EMEA region. Our presence in the EMEA region makes us a strong, future oriented partner for sectional door projects.



*“Quality Doors”*



**baufit**<sup>®</sup>

**bautech**<sup>®</sup>  
INDUSTRIAL DOORS

# Index

Industrial Doors.....	4-5
Full Vision Doors.....	6
Industrial Door Automations.....	7-9
High Speed Roll Doors.....	10
High Speed Flex.....	11
Dock Leveller Systems.....	12
Dock Shelter Systems.....	13
Garage Doors.....	14-15
Garage Door Automation.....	16
Aluminium Sliding Doors.....	17
Accessories.....	18-19
Technical Information.....	20
Tracks And Lifting Types.....	21
Panel Models and Colors.....	22-23
Industrial Door Hardware.....	24
Torsion Spring Garage Door Hardware.....	25
Windows And Wicked Doors.....	26
Certifications.....	27





# INDUSTRIAL DOORS



Sectional doors are the best space saving solution, since they are composed of compact panels, that slide upwards through the lateral track and reinforced by a system of springs; moreover, their operation is very smooth, practical and safe.

Thanks to its design, our sectional doors can be adapted easily to any type of space. The doors should be designed and installed according to the facilities architectural structure considering the gap between the ceiling and the top of the door. You can choose between standard, low, high lift and vertical track applications.



The sectional door panels are manufactured with two sheets of roll formed embossed steel and high density polyurethane (CFC Free) foam injected between the sheets; thus achieving a high thermal and acoustic insulation and high mechanical resistance.

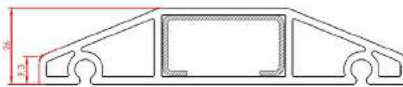

Industrial sectional doors can be equipped with wicket (service) doors and side doors they offer a very practical solution for pedestrian traffic without opening the door. Its preferred to install the side door than the wicket door but If your facility is too narrow for a side door, then we recommend an integrated wicket door.

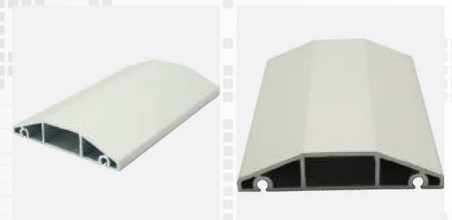

Industrial sectional doors can easily be operated automatically by electric motor or manually since the doors are balanced with the torsion springs and they are the most convenient system of closing and opening. All the drive systems have a mechanical back-up system fitted to the reduction gearbox of the electric motor, so that the sectional door can be operated with emergency chain in case of power cut off.

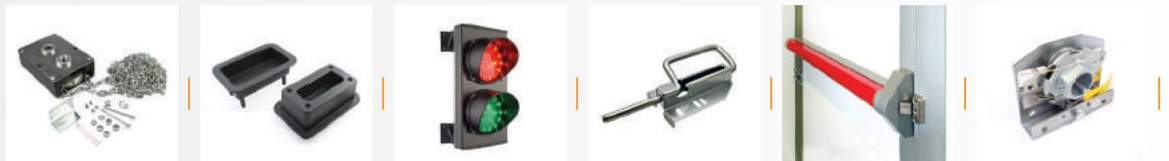

## FULL-VISION SECTIONAL DOORS



A wide variety of glazing materials and design options are available to suit the specific customer and application requirements such as translucent or opaque, partitioned or non-partitioned, tinted or transparent.

All sides of the door is insulated using special rubber seals. This high-quality seal ensures maximum insulation properties.

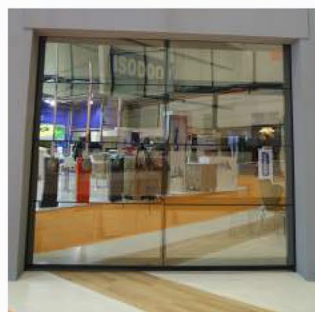

The doors can be operated by electric drive systems or by a chain hoist. Electric drive systems are suitable for doors that are operated very frequently and chain hoist operation is suitable for doors that are not operated very frequently. Obstacle detection safety system is also provided at the bottom seal of the door.

Good visibility and natural day light  
When optimal natural light is required, Isodoor offers full vision sectional doors. Full Vision sectional doors are the perfect combination of aesthetic and light since large glazing provides facilities with good visibility and lets in natural light.



This sectional door is available in different options and design alternatives. Full vision doors are manufactured according to customer requirements. The anodized, aluminum sections of the full vision sectional door can be produced with a wide variety of options and colors. The door panels are produced as 500 mm – 610 mm from finger-safe aluminum profiles.



# INDUSTRIAL DOOR AUTOMATIONS

## STA & STAC SERIES AUTOMATION SYSTEMS



### CS 300 Control Card

- Comprehensive functions
- Programmable 4 relay outputs
- Text display LCD(optional)
- Large connection area with many connection
- Power supply for external devices
- Opto laser and pneumatic safety system suitable for use



### STA / STAC Series Products

The STA / STAC series of drives are optimally designed for spring balanced sectional doors. This guarantees a drive that is specially developed for this particular application, with a special motor to supply a great deal of power in the smallest of spaces. The drive is therefore extremely compact and its housing very slim.

External or integrated controls:  
All drives in the STA series work on the basis of external controls, whereas the drives in the STAC have integrated controls.

### Characteristics:

- Pressure cast aluminium housing
- Rolled worm shaft
- Double worm shaft bearings
- Thermal protection in the motor windings
- 230 / 400V / 50 Hz / 3~, special options on request
- Plug-in connections
- For combination with an extensive control program
- Easy modification from crank to chain



### CS 250 Control Card

- The control over the end position sensor
- Without self stopping <<OFF>> direction of movement
- Without self stopping <<OPEN>> direction of movement
- The last position with external 3-button
- Opto laser or pneumatic safety system suitable for use



TECHNICAL DETAILS	STA/STAC 1-10-24	STA 1-12-19	STA 1-8-45	STAC 1-5-24	UNIT
Driving torque	100	120	80	50	Nm
Static holding torque	600	600	600	600	Nm
Driving motor speed	24	19	45	24	rpm
Motor output	0,37	0,55	0,55	0,25	kW
Operating voltage	400 / 3~	400 / 3~	400 / 3~	400 / 3~	V
Mains frequency	50	50	50	50	Hz
Control voltage	24	24	24	24	V
Motor current rating	2	1,8	2,2	1,3	A
* Max. cycles per hour	20	30	20	20	
Supply cable, on site	5 x 1,5	5 x 1,5	5 x 1,5	5 x 1,5	mm
Fuse protection, on site	10	10	10	10	A
Protection grade	54	54	54	54	IP
** Temperature range	-20 / +60	-20 / +60	-20 / +60	-20 / +60	°C
Continuous sound pressure level	< 70	< 70	< 70	< 70	dB (A)
Maximum output revolutions	20	20	20	20	
Ø Sleeve shaft	25,4	25,4	25,4	25,4	mm
Maximum Door Weight	450/35	750/45	450/35	350/16	kg/m <sup>2</sup>

\*Each cycle comprises one opening and closing movement of the door. The values given assume an even distribution.

\*\* temperature range < -20 °C: oil grade and electric heating on request



### BAU-EM 524

(EP-400 Control Panel Included)  
 Shaft Diameter: 25,4 mm , Max. Torque : 120 N  
 Max. Door Size: 40 m<sup>2</sup>  
 Output Speed: 24 Rpm - Motor Power: 0,50 KW  
 Operating Voltage: 400 V /3~  
 Frequency: 50 Hz - Max. Current: 2 A  
 Control Voltage: 24 V - Motor's Cycle: S3-60% ED  
 Working Temperature: - 20 /+ 60 °C  
 Protection Coefficient: IP 54  
 Strong – Silent – Adjustment Encoder  
 Sensitive pneumatic safety system is included in set.  
 You can use caraskal system for manual.  
 Chain length is 4 x 2 = 8 meters.

### BAU-EM 324

(EP-400 Control Panel Included)  
 Shaft Diameter: 25,4 mm , Max. Torque : 100 N  
 Max. Door Size: 35 m<sup>2</sup>  
 Output Speed: 24 Rpm - Motor Power: 0,37 KW  
 Operating Voltage: 400 V /3~  
 Frequency: 50 Hz - Max. Current: 2 A  
 Control Voltage: 24 V - Motor's Cycle: S3-60% ED  
 Working Temperature: - 20 /+ 60 °C  
 Protection Coefficient: IP 54  
 Strong – Silent – Adjustment Encoder  
 Sensitive pneumatic safety system is included in set.  
 You can use caraskal system for manual.  
 Chain length is 4 x 2 = 8 meters.



### BAU-EM OS

Opto – laser bottom safety device's eyes.



### BAU-EM SKS

Spiral cable for opto – laser safety systems.



### BAU-KBL-PNMTK

Wireless Pneumatic safety systems set



### BAU-KBL

Cable between motor and control panel.



# AUTOMATIONS



Nice

## NICE SD 100-24

(D-PRO Control Panel Included)  
Shaft Diameter: 25,4 mm , Max. Torque : 100 N  
Max. Door Size: 35 m<sup>2</sup>  
Output Speed: 24 Rpm - Motor Power: 0,37 KW  
Operating Voltage: 400 V /3~  
Frequency: 50 Hz - Max. Current: 2 A  
Control Voltage: 24 V - Motor's Cycle: S3-60% ED  
Working Temperature: - 20 /+ 60 °C  
Protection Coefficient: IP 54  
Strong – Silent – Adjustment Encoder  
Opto-Laser safety system is included in set.  
You can use caraskal system for manual.  
Chain length is 4 x 2 = 8 meters.

## NICE SD 140-20

(D-PRO Control Panel Included)  
Shaft Diameter: 25,4 mm , Max. Torque : 140 N  
Max. Door Size: 45 m<sup>2</sup>  
Output Speed: 24 Rpm - Motor Power: 0,55 KW  
Operating Voltage: 400 V /3~  
Frequency: 50 Hz - Max. Current: 2 A  
Control Voltage: 24 V - Motor's Cycle: S3-60% ED  
Working Temperature: - 20 /+ 60 °C  
Protection Coefficient: IP 54  
Strong – Silent – Adjustment Encoder  
Opto-Laser safety system is included in set.  
You can use caraskal system for manual.  
Chain length is 4 x 2 = 8 meters.



## GFA SE 14.21

(TS 970 Control Panel Included)  
Shaft Diameter: 25,4 mm , Max. Torque : 120 N  
Max. Door Size: 45 m<sup>2</sup>  
Output Speed: 24 Rpm - Motor Power: 0,37 KW  
Operating Voltage: 400 V /3~  
Frequency: 50 Hz - Max. Current: 2.2 A  
Control Voltage: 24 V - Motor's Cycle: S3-60% ED  
Working Temperature: - 20 /+ 60 °C  
Protection Coefficient: IP 65  
Strong – Silent – Adjustment Encoder  
Opto-Laser safety system is included in set.  
You can use caraskal system for manual.  
Chain length is 4 x 2 = 8 meters.



## GFA SE 9.24

(TS 970 Control Panel Included)  
Shaft Diameter: 25,4 mm , Max. Torque : 90 N  
Max. Door Size: 35 m<sup>2</sup>  
Output Speed: 24 Rpm - Motor Power: 0,37 KW  
Operating Voltage: 400 V /3~  
Frequency: 50 Hz - Max. Current: 2 A  
Control Voltage: 24 V - Motor's Cycle: S3-60% ED  
Working Temperature: - 20 /+ 60 °C  
Protection Coefficient: IP 65  
Strong – Silent – Adjustment Encoder  
Opto-Laser safety system is included in set.  
You can use caraskal system for manual.  
Chain length is 4 x 2 = 8 meters.



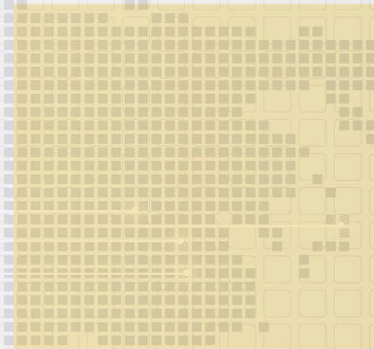

TECHNICAL SPECIFICATIONS	
PVC Awning	0,8 mm 900gr/m2 Panama 1100 dtex MEHLER, heat resistance -30 C + 70C degree
Side rails and mechanism	2 mm galvanized steel
Mechanism's inside parts	3 mm - 5 mm Special design laser cutting galvanised steel
Cord and Seal	Special desing EPDM
Support Bar	12 mm solid shaft
Wind resistance	60km/m2
Engine	380 VAC changing engine according to door size(0,75 kW- 5,5kW)
Reducer	63-70 cast aluminum body (YILMAZ REDUCTOR )
Brake	200 VDC electromagnetic brake
Switch	Chain transferred cycle limit switch (RAVIOLI - ITALY)
Safety	Safe photocell(S) current renovation(S) pneumatic bottom bar(O) size photocell(O)
Flasher/Alarm	Optional
Control Unit	380 VAC current limiting , phase control system compatible with access control system
Cabin	Plastic (S) stainless (O)
Protection class	IP65
Operation functions	On-stop-off and emergency buttons
Adjustable fuctions	Automatic shutdown time and Manuel operation
Door operation speed	0,7m/sn(S), can be increased with driver
Window	Eye level one row 45 cm , can be increased
Color options	Grey, White, blue, black, yellow , orange, red, green



# HIGH SPEED FLEX

## TECHNA FLEX



### TECHNICAL SPECIFICATIONS

PVC Awning	0,8mm 900gr/m2 Panama 1100 dtex MEHLER, heat resistance -30 C + 70 C
Side rails and mechanism	2mm galvanized steel (until 6000mm)
Mechanism's inside parts	3 mm - 5 mm Special design laser cutting galvanised steel
Cord and Seal	Special desing EPDM
Support Bar	21-27mm galvanized pipe
Wind resistance	125 km/m <sup>2</sup>
Engine	380 VAC changing engine according to door size(0,75 kW- 5,5kW)
Reducer	63-70 cast aluminum body ( YILMAZ REDUCTOR )
Brake	200 VDC electromagnetic brake
Switch	Connecting chain switch (RAVIOLI - ITALY)
Safety	Safe photocell(S) current renovation(S) pneumatic bottom bar(O) size photocell(O))
Flasher/Alarm	Optional
Control Unit	380 VAC current limiting , phase control system, compatible with access control system
Cabin	Plastic (S) stainless (O)
Protection class	IP65
Operation functions	On-stop-off and emergency buttons
Adjustable fuctions	Automatic shutdown time and Manuel operation
Door operation speed	0,7m/sn(S), can be increased
Window	Eye level one row 45 cm , can be increased
Color options	Grey, White, blue, black, yellow , orange, red, green





Bautech loading ramps ensure solutions for quick loading and unloading. It fills the space between the door and vehicle. Prevent slippage and suitable for all kinds of loads



**Hydraulic dock leveller with telescopic lip PT**

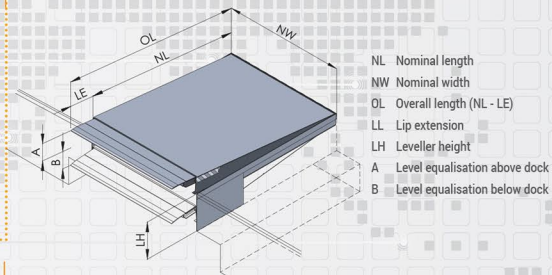

- NL Nominal length
- NW Nominal width
- OL Overall length (NL - LE)
- LL Lip extension
- LH Leveller height
- A Level equalisation above dock
- B Level equalisation below dock

**Hydraulic dock leveller  
Hydraulic dock leveller with swing lip (PS)  
Hydraulic dock leveller with telescopic lip (PT)**

**Hydraulic dock leveller with swing lip PS**

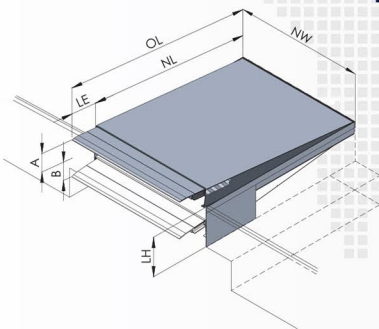

- NL Nominal length
- NW Nominal width
- OL Overall length NL + (LL - 65)
- LL Lip length
- LH Leveller height
- A Level equalisation above dock
- B Level equalisation below dock

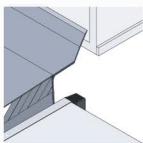

**Tapered lip**

The most cost-effective way to reduce the contact area of the swing lip is to provide it with tapered edges. This option offers 125 mm bevels on both sides. (recommended for NW ≥ 2,200)



**Fold-Down segments**

Our PS dock levellers are also available with fold-down segments. In this case the lip consists of a central element and two side elements (located on the left and right hand side). The side elements fold down independently of the central element. The lip width is reduced by 125 mm on each side so that vehicles with narrow beds can also be loaded and unloaded. When the lip returns to its rest position, the side elements are automatically locked with the central element so that the central element and side elements are lifted together during the subsequent swing-out process. (recommended for NW ≥ 2,200).

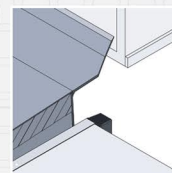

**Tapered lip**

The most cost-effective way to reduce the contact area of the telescopic lip is to provide it with tapered edges. This option offers 125 mm bevels on both sides. (recommended for NW ≥ 2,200).

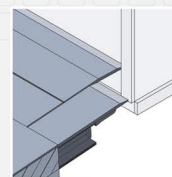

**Retracting tongues**

Our PT dock levellers are also available with retracting tongues. In this case the lip consists of a central element and two side elements (located on left and right hand side). The side elements move backwards independently of the central element. Thus, the lip width is automatically reduced by 150 mm on each side so that vehicles with narrow beds can also be loaded and unloaded. When the lip is fully retracted, the side elements are automatically locked in their original position so that the central and side elements are extended together again during the subsequent loading process. This option is only available for LE - 500. (recommended for NW ≥ 2,200)

# DOCK SHELTER SYSTEMS



## MECHANICAL DOCK SHELTER PMV

Storage and truck loading and unloading areas are different because of openings it is formed and traversed for their increased energy expenditures. Because it is essential to isolate the most effective way, PROMStahl front and rear frame of the door insulation, together with the articulated arm connected to the high-strength aluminum extrusion shapes. It is formed. Very durable PVC tarpaulin flexible 3 mm thick the frame is mounted. Lift the roof and parallel rotation system due to incorrect approaching vehicles at the front or the back-up structure. It pulled right, so right at the door approaching truck isolation is not damaged.

Visual strips that facilitate docking the front part of the gate insulation. It is arranged. Rainwater hand with an integrated rain gutter. It is discharged. The standard model in an additional vent in the upper canvas. There. Top tarp partially or fully laminated with the difference in price. Also available as model. Door insulation into three parts. It is delivered as pre-assembled and so little burden on front line. It can be secured. The advantages of this type of structure and key money. It is saving time.

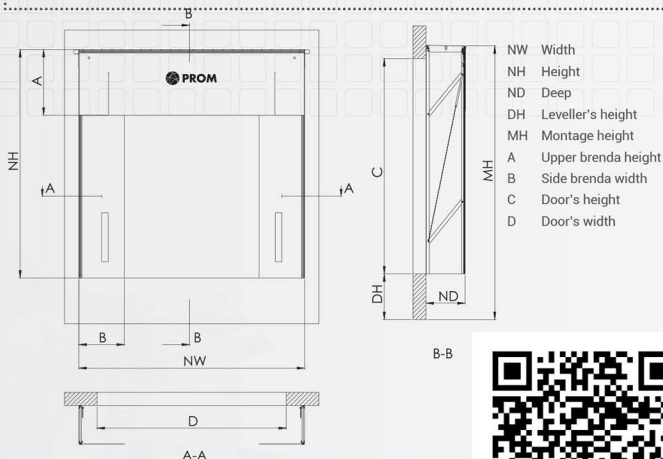

## INFLATABLE DOOR INSULATION PWI

Inflatable gate insulation PWI, optimal insulation general use. It combines the facilities. Inflatable side and top cushions. Loading range is as close to hermetically isolate. Therefore, such further cooling and air-conditioned storage area. Home. It is very convenient. Summer heat, winter cold, drafts of insects. In no way it can escape into the tank. Results in significant energy save and store less of their staff is sick. Also. It is not possible to go sneak warehouse. PROMStahl door of isolation front and rear frames of high-strength aluminum. It is formed from extruded profiles.

The side frame is extremely robust and insulation thickness of 40mm. It is produced from the panel. Inflatable top and side cushions automatically



as they adapt to the truck sizes. Thus, the loading point also effectively isolate the different sizes of trucks possible. These advantages will quickly amortize the door insulation which makes it a good investment. Three door insulation. They are delivered as pre-assembled

parts and thus less. The expensive to be secured to the front. This structure has the advantage of. It is a major time and money savings.

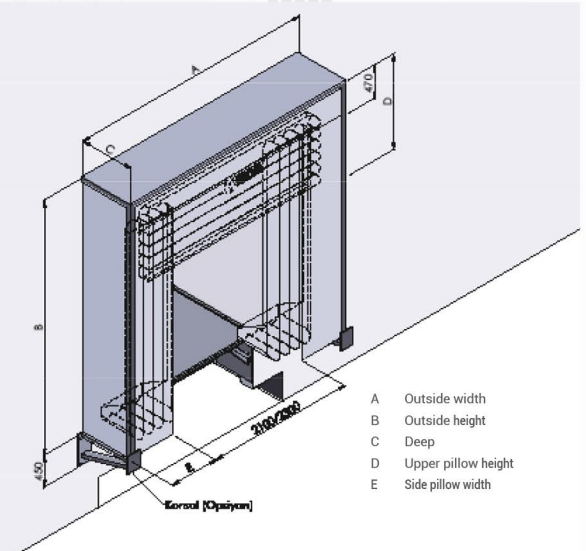

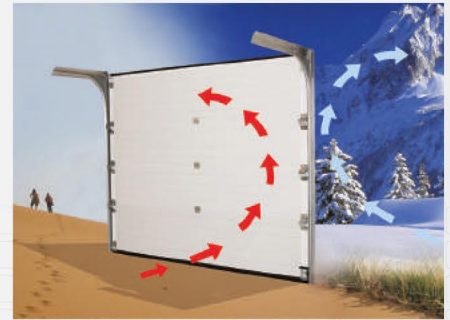

Decorative garage doors can easily be opened manually.

Prevent dust, air, rain water transition to the inside with the thermoplastic seals between panels.



All Bautech garage doors and operators are manufactured according to the strict quality management system DIN ISO 9001. Sectional garage door systems meet the high safety requirements for the European garage doors product standard EN 13241-1.

**The spring system provides a much smoother operation than conventional doors, which is particularly useful on larger sized doors. All Sectional garage doors can be either manually or remotely operated.**

### FEATURES & BENEFITS

- 40 mm thick, double-skinned steel sections
- Extremely robust and highly insulating
- Large range of decorative embossed designs and woodgrain patterns.
- Almost all RAL colors are optionally available
- Vertical travel for maximum use of drive space
- They open upwards and run parallel to the ceiling and require little headroom
- In case of damage, sections or panels can be replaced individually
- Fit easily into very wide openings
- matching side doors or integrated wicket doors also available
- Can be fitted with optional windows

### Safety and Security

Sectional door panels are also safe, with anti-entrapment design between the sections to prevent finger trapping, and a number of other safety features that meet all current legal regulations.

Electrically operated doors stop immediately if an obstacle is detected on the door way and opens for security purposes.

Emergency release locking system is used in case of malfunction or power failure, the emergency key release is especially useful if there is no other access into the garage



# GARAGE DOORS

Made from hinged panels that slide vertically along tracks as the door opens and closes, save space in front and inside of your garage.

For openings with low ceiling heights, sectional garage doors are often a better fit than other doors.



All Bautech garage doors and operators are tested by recognized institutes both individually and in combination.

ISO 220 garage doors with torsion springs are installed with 220 clearance above the door.

**Sectional doors are particularly recommended for garages with very good thermal insulation, sealed panels ensure high thermal insulation. The seals around the perimeter of the door and between the door panels ensure a great insulation from the external environment.**



Bautech garage doors are first class products, manufactured and assembled in house for your safety and security. All Sectional garage doors supplied by Bautech are CFC free, polyurethane filled, double-skinned galvanized steel panel construction. The 40mm thick panel construction provides incredible strength, and reduces damage from knocks and bumps.

Bautech offers 2 types of sectional garage doors ISO 220 economical solution and ISO 250 exclusive garage door; with the largest selection of additional features.

Sectional garage doors offer the greatest degree of aesthetic and adaptability. It comprises a number of large sections of panels that come in a wide range of designs and colors.



### THE NEW MODEL

ISO 100 garage doors with tension springs are installed with 100 clearance above the door.



## GARAGE DOORS AUTOMATIONS



### RAIL KITS MODELS

Technical Specifications	Jm.3	Jm.4
Operating Voltage	24 Vdc	24 Vdc
Maximum Current	0,7 A	1,5 A
Engine Power	600 N	1200 N
Start Time	8,9 m/dk	8,9 m/dk
Working Time	Suitable for intensive use	Suitable for intensive use
Limit Switch	Encoder, electronic	Encoder, electronic
Maximum Door Removal Area	12 m²	15 m²
Working Temperature	-20 +50 °C	-20 +50 °C
Traction Power	140 W	220 W
Ray Sets	PTCL3 / PTCL4	PTCL3 / PTCL4
Structure of Release	corded	corded
Ip Protection Coefficient	IP 40	IP 40



The one piece rail kit can be used seamlessly up to 2350 mm door height. Works quietly and doesn't bother you thanks to belt.



The two pieces rail kit can be used seamlessly up to 2350 mm door height. Works quietly and doesn't bother you thanks to belt. 1,5 m of each of part.



The two-pieces rail kit can be used seamlessly up to 2350 mm door height. Works quietly and doesn't bother you thanks to belt. 2m of each of part.



2-Channel Control Types



4-Channel Control Types



Safety photocell



Technical Specifications	BOTTICELLI	EOS 120
Max. Door Height	80 kg	120 kg
Control Unit	VENERE D (Included)	VENERE D (Included)
Locked / Unlocked Operation	Unlocked	Unlocked
Input Voltage	230V ~ ± 10%, 50 Hz	230V ~ ± 10%, 50 Hz
Operating Voltage	24V	24V
Captured average power	240 W	240 W
Max concentrated force	800 N	1200 N
Work Speed	5 mt/minutes	5 mt/minutes
Effect Against Shock	Electronic torque limiting control unit	Electronic torque limiting control unit
Limit Switch	Encoder	Encoder
Structure of Release	Rope	Rope
Frequency of Use	Use Hard Intensity	Use Hard Intensity
Operating Temperature	-15°C with +60°C	-15°C with +60°C
Protection Factor	IPX0	IPX0
Mechanism Weight	50N (~5 kg)	80N (~8 kg)

### ARGO / ARGO G

Control Unit	VENERE D
Locked / Unlocked Operation	Locked
Input Voltage	230V ~ ± 10%, 50 Hz
Operating Voltage	24V
Captured average power	70W
Max concentrated force	20 m² / 35m²
Work Speed	30RPM / 18 RPM
Effect Against Shock	Electronic torque limiting control unit
Limit Switch Modeli	Encoder
The Release	with RCA
Frequency of Use	Use Hard Intensity
Operating Temperature	-20°C with +55°C
Protection Factor	IPX0
Mechanism Weight	100N (~10 kg)



### ISO-GM-600

24v DC motor – intensive use.  
 Operating Voltage: 230 AC  
 Maximum Force: 600 N  
 Maximum door size: 10 m  
 Maximum Current: 0,7 A  
 Opening Speed: 9 m/sec  
 Operating Temperature : - 20°C / + 60°C  
 Electronic limit switch with encoder.  
 You can encode 20 transmitters to board.  
 1 piece 2 channels transmitter is included in box.  
 Belt rail is not included in box.

### ISO-GM-1000

24v DC motor – intensive use.  
 Operating Voltage: 230 AC  
 Maximum Force: 1000 N  
 Maximum door size: 14 m  
 Maximum Current: 0,7 A  
 Opening Speed: 9 m/sec  
 Operating Temperature : - 20°C / + 60°C  
 Electronic limit switch with encoder.  
 You can encode 20 transmitters to board.  
 1 piece 2 channels transmitter is included in box.  
 Belt rail is not included in box.



ISO-GM-DK



ISO-GM-KP



ISO-GM-KMD



ISO-GM-RT-3100  
 ISO-GM-RT-3400  
 ISO-GM-RT-3900  
 ISO-GM-RT-4200



# ALUMINIUM SLIDING DOORS

Aluminium sliding doors protects interior and exterior of the heat balance and compatible with all access control systems.



This door can use in crowded places such as shopping centers. It can be opened manually in case of emergency

Technical Specifications	VISTASL1(one wing)	VISTA SL2(Double wings)
Control Unit	ARIA	ARIA
Operating Voltage	230 V $\pm$ 10%, 50 Hz	230 V $\pm$ 10%, 50 Hz
Average power drawn	230 W	230 W
Frequency of use	Continuous	Continuous
Crossing the gap	75 cm	80 cm
Max. opening	255 cm	290 cm
Max. wing height	150 kg	120+120 kg
Mechanism size	166x155 mm	166x155 mm
Partial opening	Opening width %10-70	Opening width %10-70
Effect collision	Microprocessor and encoder	Microprocessor and encoder
Operating temperature	0°-55 °C	0°-55 °C
Height adjustment wheel carrier	Until 16 mm	Until 16 mm



## SUITABLE MODEL FOR ALL YOUR NEEDS

- 150 kg carrying capacity on one side, 120 + 120 kg carrying capacity on double sides
- Wide range of accessories
- Dunker engine, Filtered transformer system ,3 wheel carrier, rubber hinge and special profiles.
- Easy programming of control unit
- Ability to work with optional battery

## SIMPLE INSTALLATION

- It has control unit.
- Ability to work with the optional VISTA SEL keypad
- Easy installation
- Automatic adjustment with a single key
- Adjustable opening and closing speed
- Adjustable torque option
- Ability to work in line with the fire system
- Programmable with hand device
- Concealed installation cables



# ACCESSORIES



MUSHROOM BUTTON



BFT PHOTOCELL

BFT RECEIVER



PASSWORD CONTROL PANEL

GRAGE DOORS HANDLE



BENINCA COLORED REMOTE CONTROL



BENINCA LED



BENINCA GRAY REMOTE CONTROL

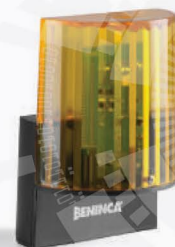

# ACCESSORIES



CHAIN HOIST SYSTEM



BFT 2 CHANNEL  
REMOTE CONTROL

WICKED DOORS  
PANIC BAR SYSTEM



BFT 4 CHANNEL  
REMOTE CONTROL



SINGLE TOUCH  
BUTTON SYSTEM

BENINCA  
PHOTOCELL



BENINCA 2  
CHANNEL  
REMOTE  
CONTROL



TOUCH SENSOR



BENINCA 2 CHANNEL  
REMOTE CONTROL



BENINCA  
RECEIVER CARD





# TRACK AND LIFTING TYPES

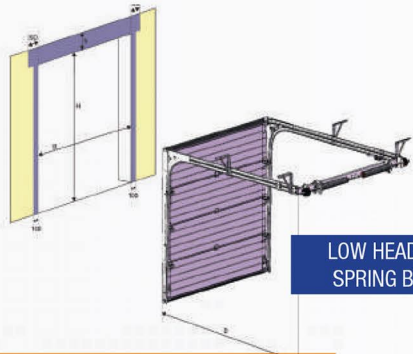

LOW HEADROOM  
SPRING BEHIND

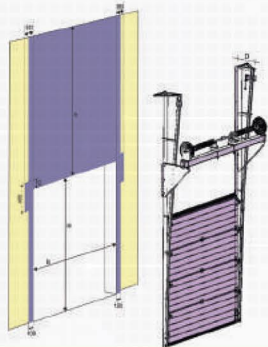

VERTICAL LIFT  
SPRING CENTER

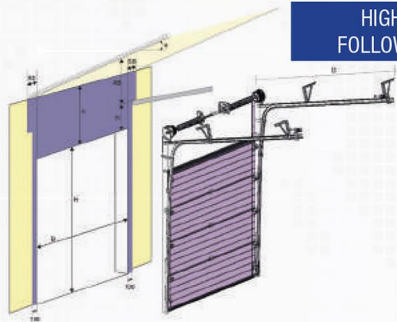

HIGH LIFT  
FOLLOW ROOF

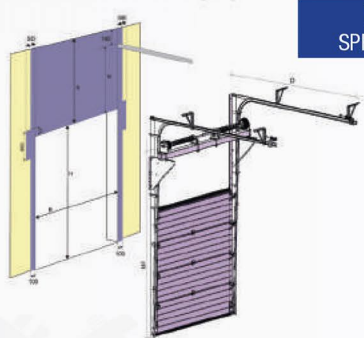

HIGH LIFT  
SPRING CENTER

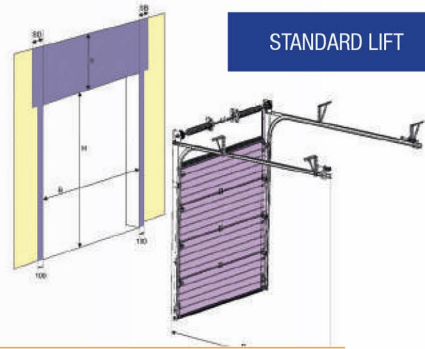

STANDARD LIFT

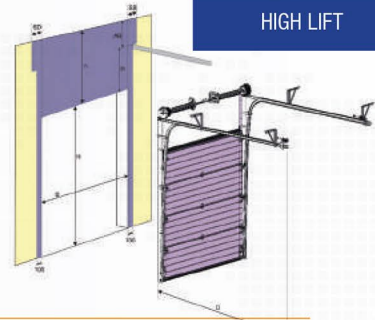

HIGH LIFT

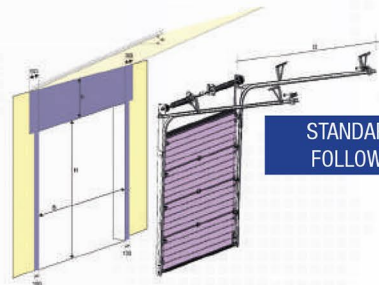

STANDARD LIFT  
FOLLOW ROOF

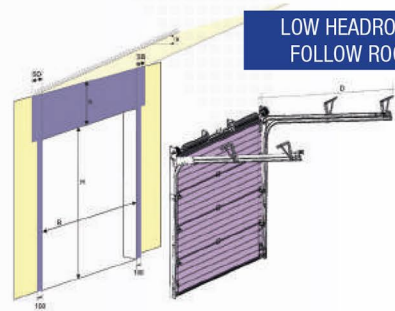

LOW HEADROOM  
FOLLOW ROOF

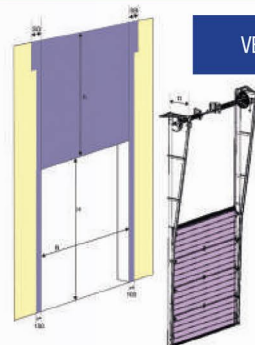

VERTICAL LIFT



## PANEL MODELS AND COLORS



RED MICRO RIBBED (RAL 3000)



BLUE MICRO RIBBED (RAL 5010)



WHITE RIBBED (RAL 9002)



WHITE MICRO RIBBED (RAL 9002)



ANTHRACITE GREY MICRO RIBBED (RAL 7016)

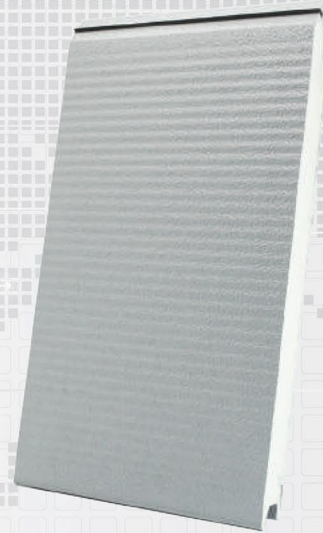

GREY MICRO RIBBED (RAL 9006)



ANTHRACITE GREY WRINKLE (RAL 7024)

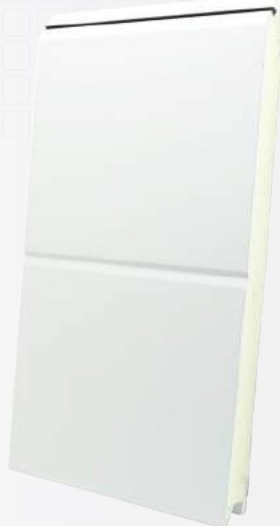

WHITE WRINKLE (RAL 9010)



WHITE MIDDLE RIBBED (RAL 9002)



## PANEL MODELS AND COLORS

ANTHRACITE GREY WRINKLE (RAL 7024)



WOODEN PATTERN RIBBED



DARK WOODEN PATTERN RIBBED

WHITE SMOOTH (RAL 9010)



WOODEN PATTERN CASSETTE



WHITE CASSETTE (RAL 9002)



PANEL'S BEND



SIDE COVERS

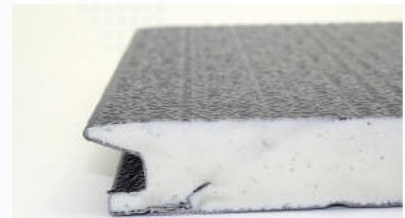

BOTTOM SECTION



PANEL AND HINGES



TOP SECTION





# TORSION SPRING GARAGE DOOR HARDWARE

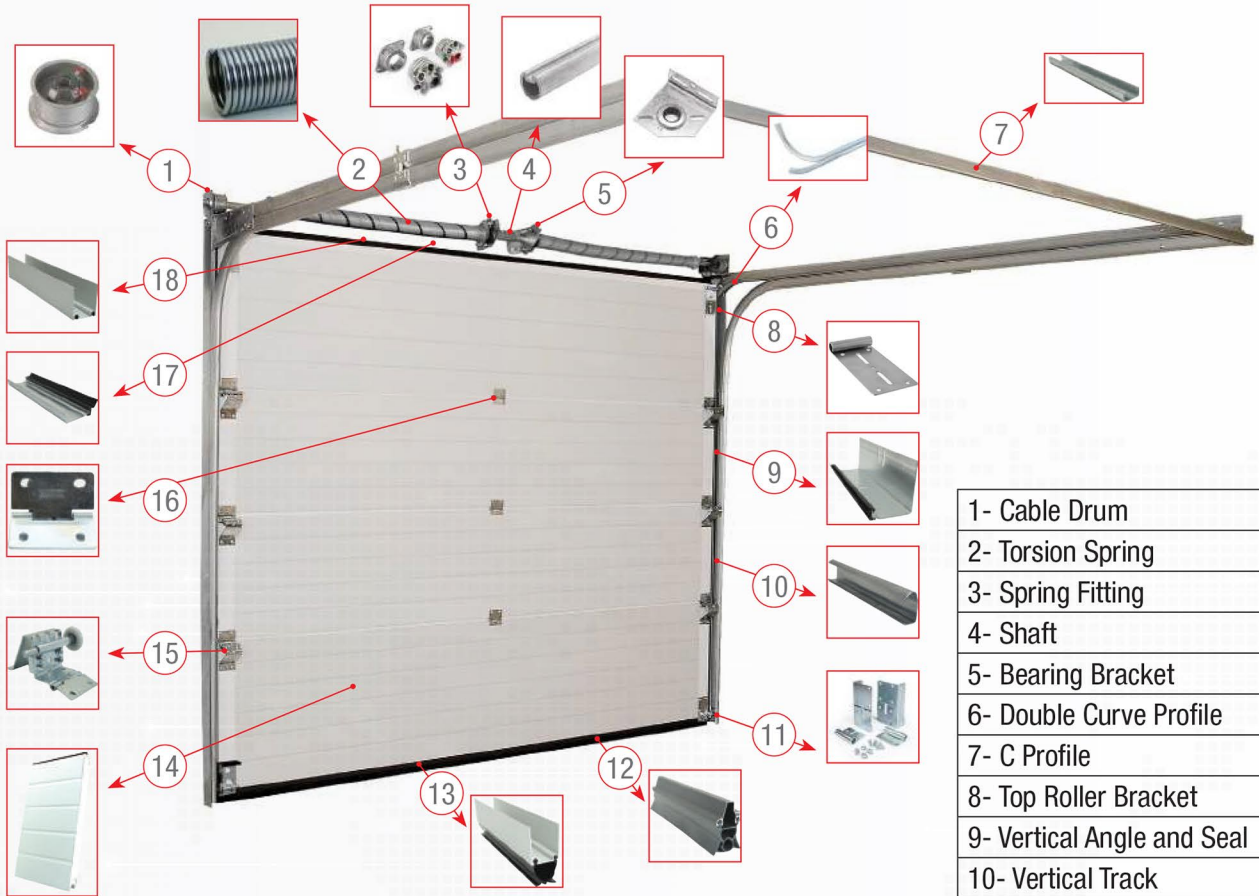

1- Cable Drum
2- Torsion Spring
3- Spring Fitting
4- Shaft
5- Bearing Bracket
6- Double Curve Profile
7- C Profile
8- Top Roller Bracket
9- Vertical Angle and Seal
10- Vertical Track
11- Bottom Roller Bracket
12- Bottom Profile and Seal
13- Bottom Profile and Seal
14- Panel
15- Side Hinge and Roller
16- Middle Hinge
17- Top Profile and Seal
18- Top Panel Profile
19- Hinge With Fixed Model
20- Double Roller
21- Tension Spring

# TENSION SPRING GARAGE DOOR HARDWARE

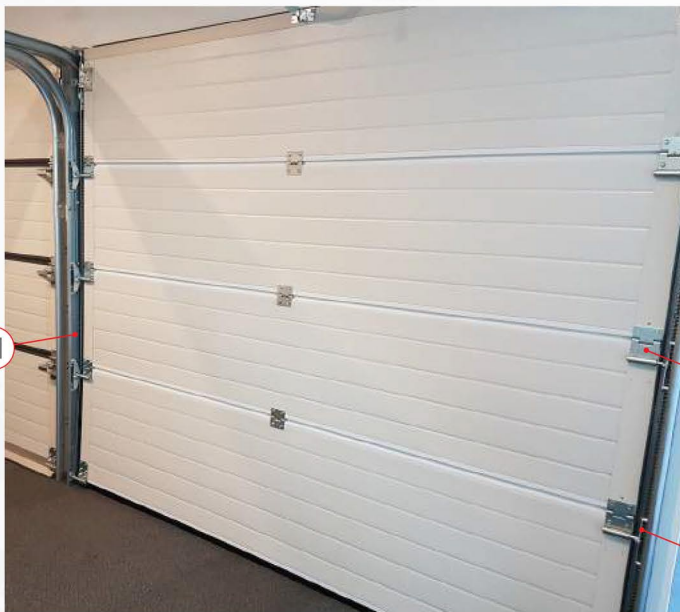



# WINDOWS AND WICKED DOORS

## POSITION OF WINDOW ACCORDING AS PANELS WIDTH AND PASS DOOR

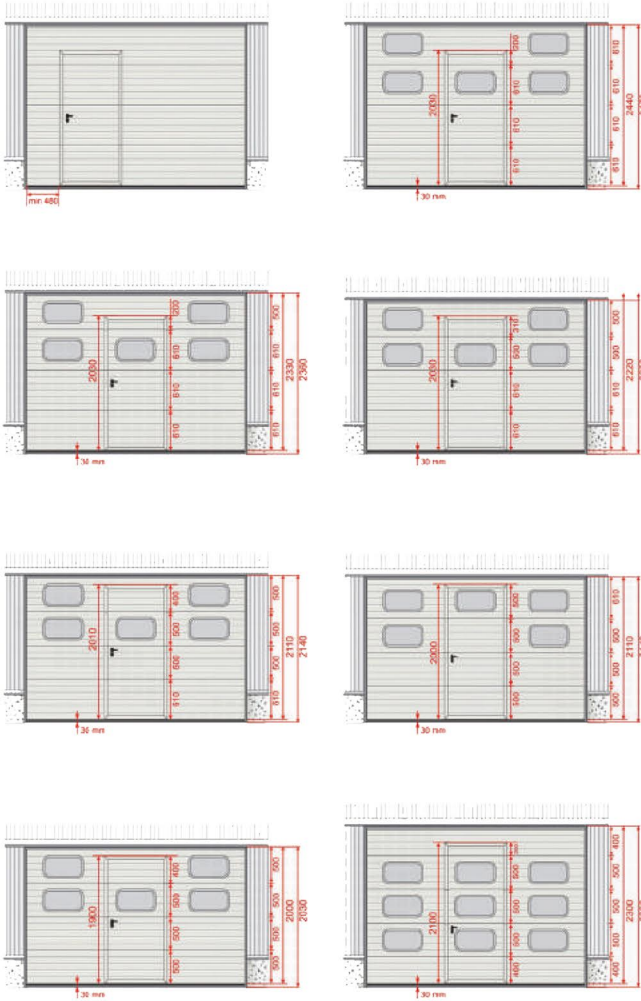

## PASS DOORS

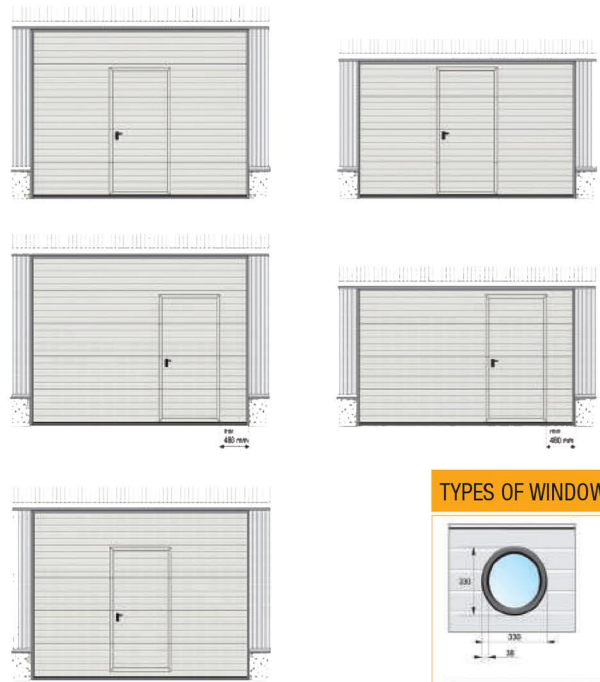

## TYPES OF WINDOW

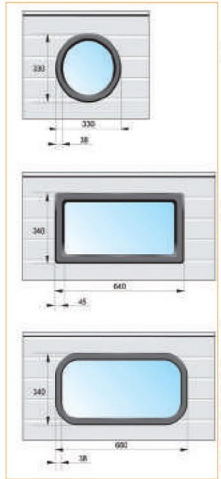

## CRITICAL DIMENSION OF THE PASS DOOR



## EXAMPLES OF RECTANGULAR WINDOWS



## POSITION OF WINDOWS ON THE PASS DOOR

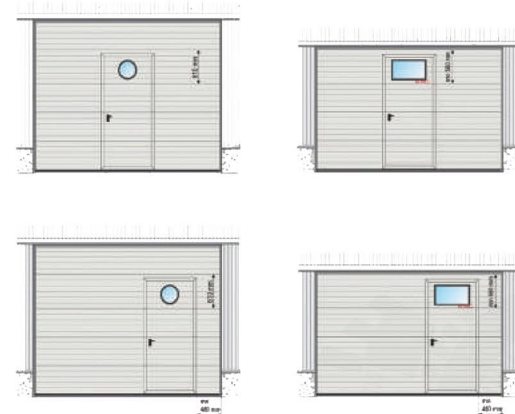



# bautech<sup>®</sup>

## INDUSTRIAL DOORS

BY



# baufit<sup>®</sup>

NETFORM 352-322 11 33



### Asean Head Office

**Baufit Asia Co.Ltd**  
321/1 Phatthanakan Rd, Khwaeng Prawet, Khet  
Prawet, Krung Thep Maha Nakhon 10250, Thailand  
Tel : +66 21012799  
E-mail : support@baufitasia.com  
Sales : sales@baufitasia.com

### Cambodia

No.301E, National Road No 6, in front of Caltex  
Station, 12110 Phnom Pench, Cambodia  
Tel : +855 17 799 862  
E-mail : support@baufitasia.com

### Asia & Middle East

Konak Mah, Lefkose Cad. Baris Sok. Ofis + Plaza  
No:3 Kat:1 Daire no:12 PK: 16265 Nilufer/  
Bursa/Turkey  
Tel : +90 224 205 0474  
E-mail : info@baufit.com

### Balkans

Magistralni put 246, Industrijska zona Maline,  
75270, Zivinice, Bosnia/ Herzegovina  
Tel : +387 61441525  
E-mail : info@baufit.com

### Europe

SAS. SMS. 2 rue cuzin.69120 Vaulx-en-Velin Lyon/-  
FRANCE  
Tel : +99 986377473  
E-mail : info@baufit.com

[www.baufit.com](http://www.baufit.com)